

RL 158.14

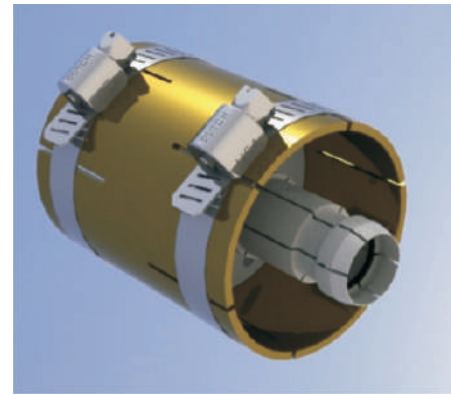

RL 158.35



RL 158.32



RL 158.01

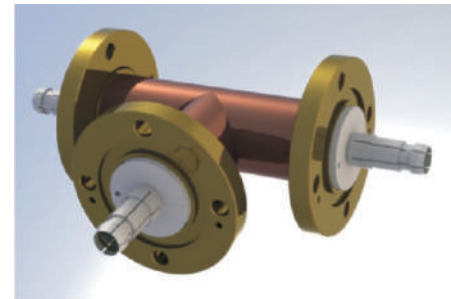

RL 158.19

- Outer Conductor: high conductivity hard drawn copper tubing ($\varnothing 41.3$ mm. x $\varnothing 38.8$ mm.)
- Inner Conductor: high conductivity hard drawn copper tubing ($\varnothing 16.9$ mm. x $\varnothing 14.9$ mm.)
- Insulation Material: virgin PTFE

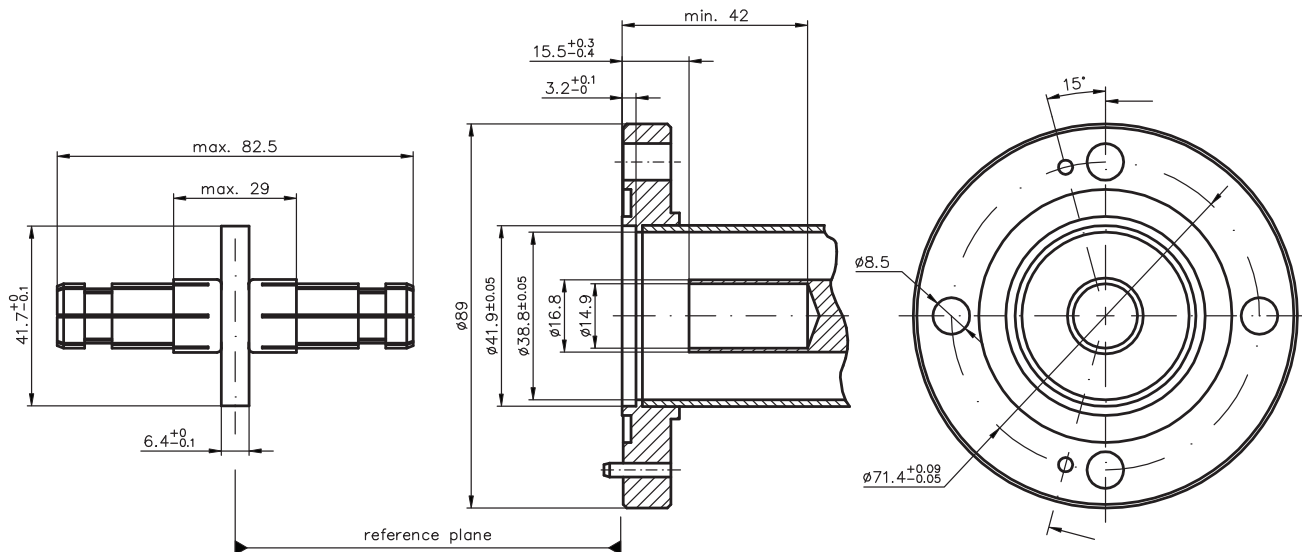

* All dimensions shown are in millimeters.
 * Drawings not to scale.

Mating Face Dimension - 1 5/8"
 (EIA standard RS-225)



Line size 1 5/8"

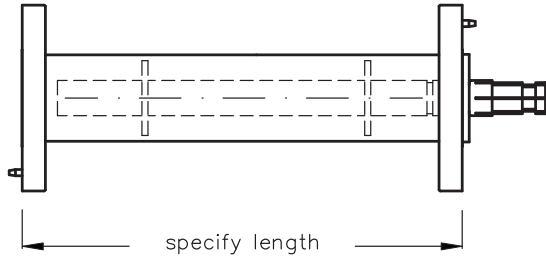

Line assembly, flanged with fixed and swivel flange. Brass and copper construction. Includes one anchor insulator conductor connector, silicone O-ring and stainless steel hardware set.

RL 158.01

Line size 1 5/8"

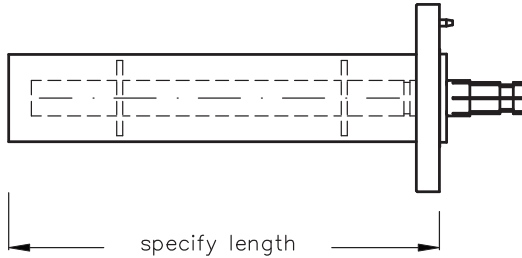

Line assembly, one end fixed flanged. Includes one anchor insulator conductor connector, silicone O-ring and stainless steel hardware set.

RL 158.02

Line size 1 5/8"

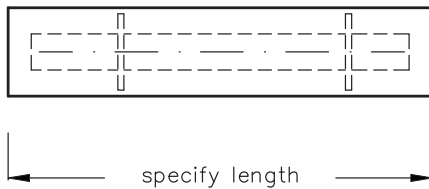

Line assembly, unflanged, no insulator conductor connector or hardware.

RL 158.04

Line size 1 5/8"

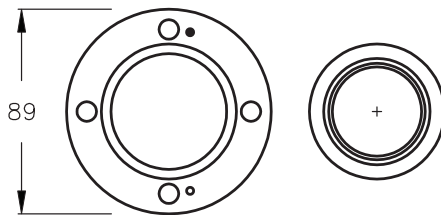

Swivel EIA flange, brass. Includes only sliding and fixed ring prepared for silver brazing to outer conducting tubing.

RL 158.06

Line size 1 5/8"

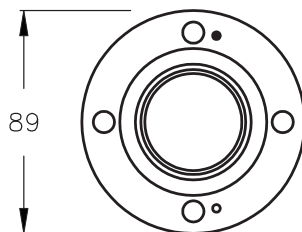

Fixed EIA flange prepared for silver brazing to outer conducting tubing.

RL 158.08



* All dimensions shown are in millimeters.
* Drawings not to scale.



Line size 1 5/8"

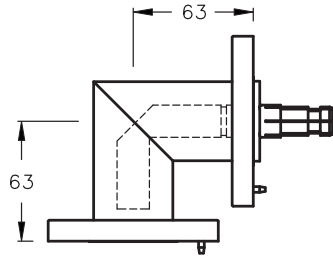

Miter elbow 90°, swivel EIA flanges on both ends, brass and copper construction. Includes unsupported inner conductor, one anchor insulator conductor connector, silicone O-ring and stainless steel hardware set.

RL 158.11

Line size 1 5/8"

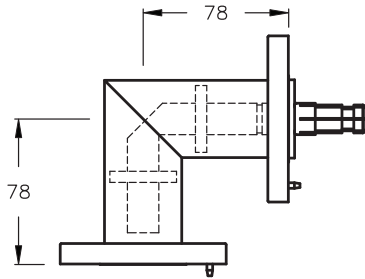

Miter elbow 90°, swivel EIA flanges on both ends, brass and copper construction. Includes supported inner conductor, anchor insulator conductor connector, silicone O-ring and stainless steel hardware set.

RL 158.14

Line size 1 5/8"

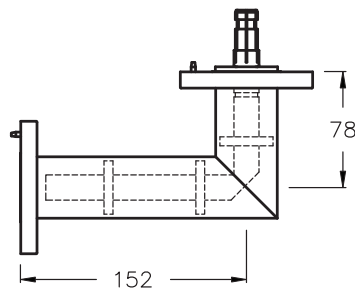

Miter elbow 90°-unequal legs, swivel EIA flanges on both ends, brass and copper construction. Includes supported inner conductor, one anchor insulator conductor connector, silicone O-ring and stainless steel hardware set.

RL 158.16

Line size 1 5/8"

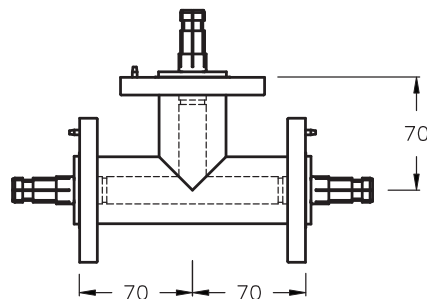

Tee assembly, swivel EIA flanges. Includes three anchor insulator connectors, O-rings and hardware sets.

RL 158.19

Line size 1 5/8"

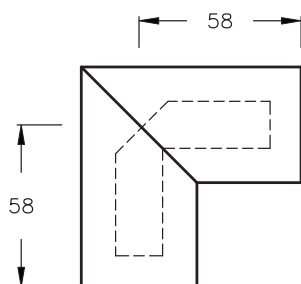

Miter elbow 90°-unflanged, copper construction. Includes only one unsupported inner conductor.

RL 158.22



* All dimensions shown are in millimeters.
* Drawings not to scale.



Line size 1 5/8"

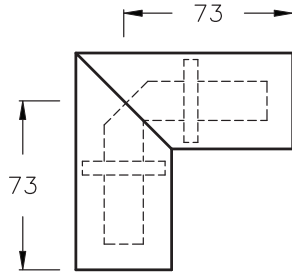

Miter elbow 90°-unflanged, long legs, copper construction. Includes only one supported inner conductor.

RL 158.25

Line size 1 5/8"

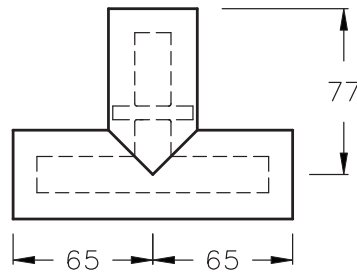

Tee assembly, unflanged, copper construction. Includes only supported inner conductor.

RL 158.28

Line size 1 5/8"

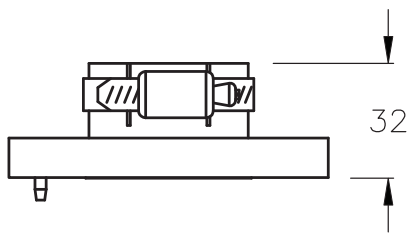

Unpressurized EIA field flange for indoor use. Includes one stainless steel hose clamp and hardware set.

RL 158.30

Line size 1 5/8"

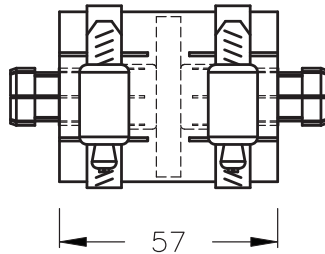

Line coupling for connection of unflanged lines. Includes supported inner conductor connector and two stainless steel hose clamps.

RL 158.32

Line size 1 5/8"

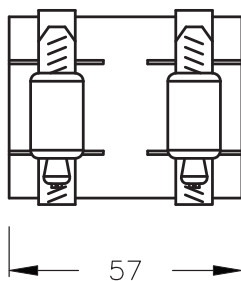

Line coupling for connection of unflanged lines. No inner conductor connector. Includes two stainless steel hose clamps (does not increase outer conductor length).

RL 158.33



* All dimensions shown are in millimeters.
* Drawings not to scale.



Line size 1 5/8"

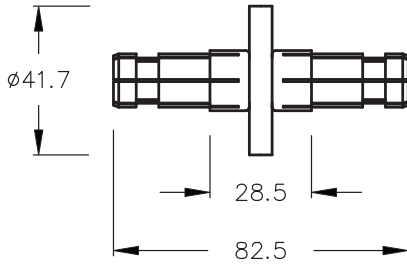

Anchor insulator conductor connector, for EIA flange connection, silver plated. **Standard length.**

RL 158.35

Line size 1 5/8"

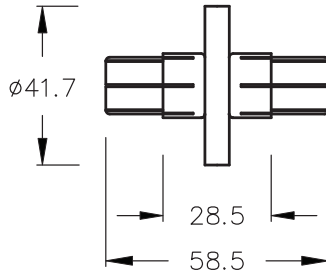

Anchor insulator conductor connector, for EIA flange connection, silver plated. **Short version.**

RL 158.36

Line size 1 5/8"

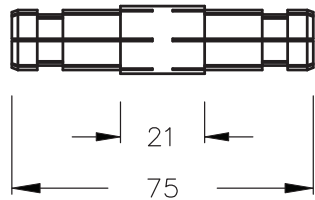

Unsupported inner conductor connector.

RL 158.40

Line size 1 5/8"

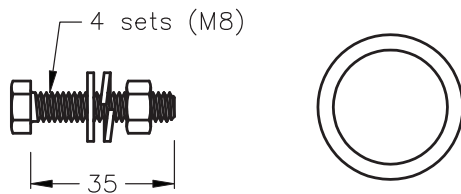

Stainless steel hardware set with silicone rubber O-ring.

RL 158.45

Line size 1 5/8"

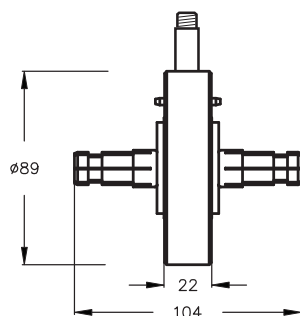

Gas barrier with silicone O-ring and stainless steel hardware set.

RL 158.50



* All dimensions shown are in millimeters.
* Drawings not to scale.

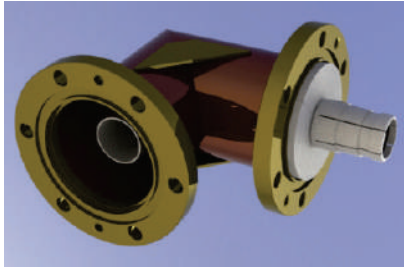

RL 318.11

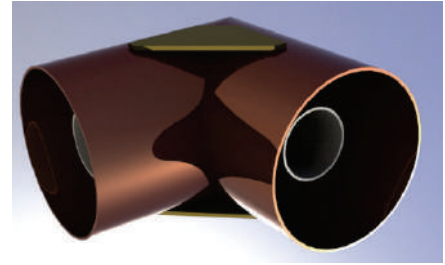

RL 318.22

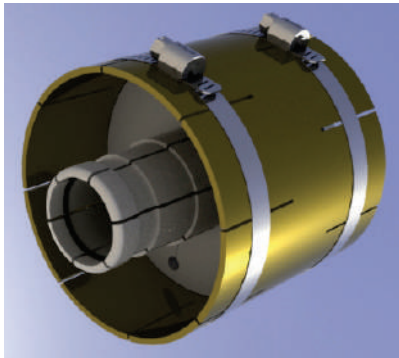

RL 318.32



RL 318.35

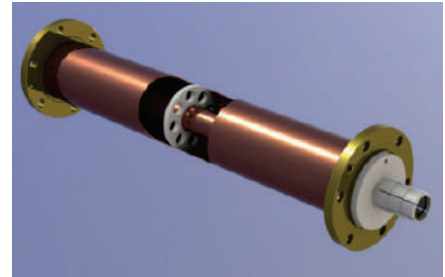

RL 318.01

- Outer Conductor: high conductivity hard drawn copper tubing ($\varnothing 79.4$ mm. x $\varnothing 76.9$ mm.)
- Inner Conductor: high conductivity hard drawn copper tubing ($\varnothing 33.4$ mm. x $\varnothing 31.3$ mm.)
- Insulation Material: virgin PTFE

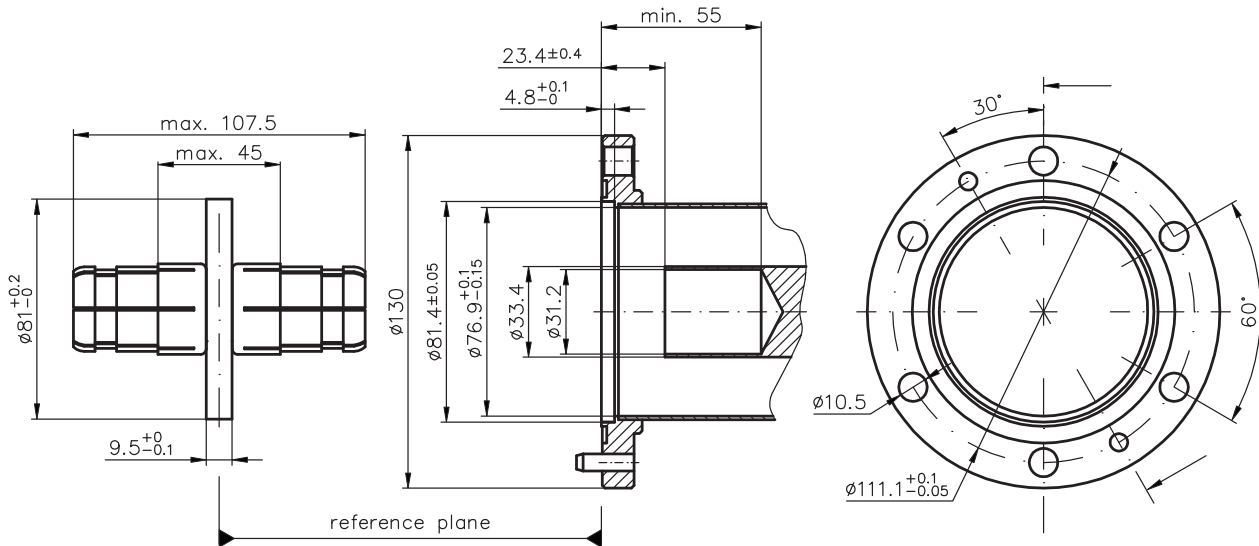

* All dimensions shown are in millimeters.
 * Drawings not to scale.

Mating Face Dimension - 3 1/8"
 (EIA standard RS-225)



Line size 3 1/8"

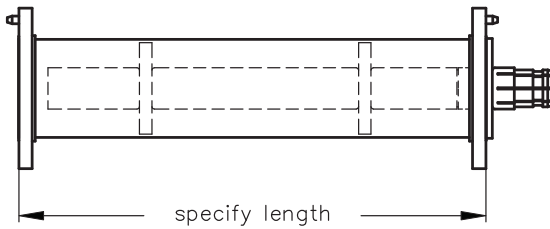

Line assembly, flanged with fixed and swivel flange. Brass and copper construction. Includes one anchor insulator conductor connector, silicone O-ring and stainless steel hardware set.

RL 318.01

Line size 3 1/8"

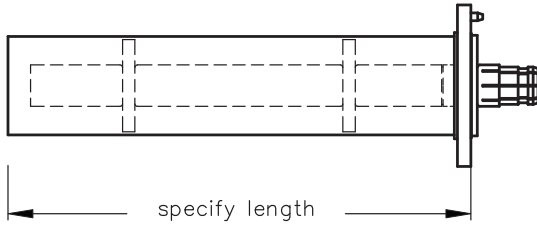

Line assembly, one end fixed flanged. Includes one anchor insulator conductor connector, silicone O-ring and stainless steel hardware set.

RL 318.02

Line size 3 1/8"

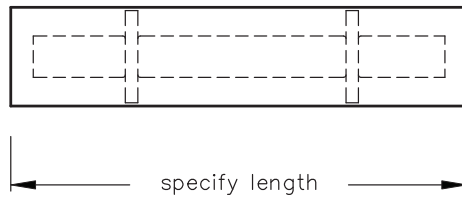

Line assembly, unflanged, no insulator conductor connector or hardware.

RL 318.04

Line size 3 1/8"

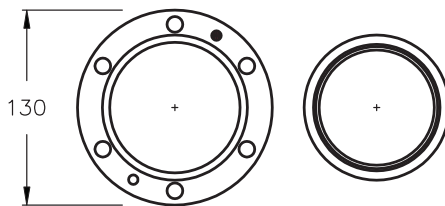

Swivel EIA flange, brass. Includes only sliding and fixed ring prepared for silver brazing to outer conducting tubing.

RL 318.06

Line size 3 1/8"

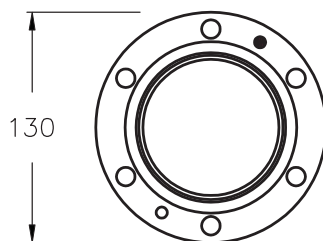

Fixed EIA flange with silver solder ring insert for silver brazing to outer conducting tubing.

RL 318.08



* All dimensions shown are in millimeters.
* Drawings not to scale.



Line size 3 1/8"

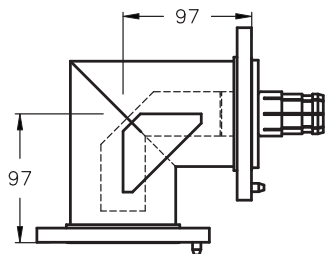

Miter elbow 90°, swivel EIA flanges on both ends, reinforced outside, brass and copper construction. Includes unsupported inner conductor, one anchor insulator conductor connector, silicone O-ring and stainless steel hardware set.

RL 318.11

Line size 3 1/8"

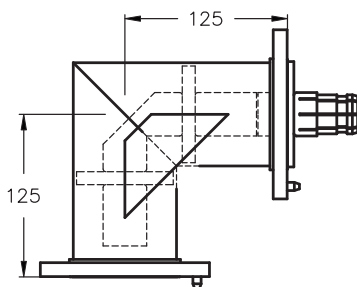

Miter elbow 90°, swivel EIA flanges on both ends, reinforced outside, brass and copper construction. Includes supported inner conductor, anchor insulator conductor connector, silicone O-ring and stainless steel hardware set.

RL 318.14

Line size 3 1/8"

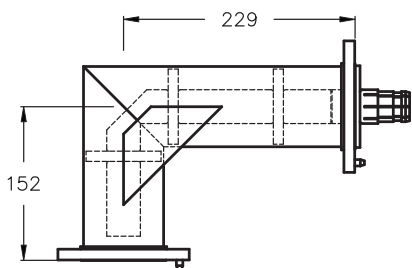

Miter elbow 90°-unequal legs, swivel EIA flanges on both ends, reinforced outside, brass and copper construction. Includes supported inner conductor, one anchor insulator conductor connector, silicone O-ring and stainless steel hardware set.

RL 318.16

Line size 3 1/8"

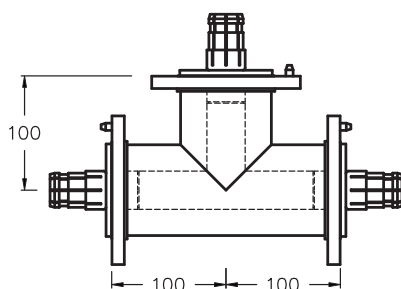

Tee assembly, swivel EIA flanges. Includes three anchor insulator connectors, O-rings and hardware sets.

RL 318.19

Line size 3 1/8"

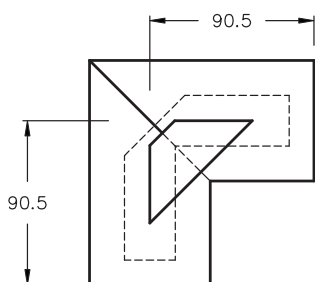

Miter elbow 90°-unflanged, reinforced outside, copper construction. Includes only one unsupported inner conductor.

RL 318.22



* All dimensions shown are in millimeters.
* Drawings not to scale.



Line size 3 1/8"

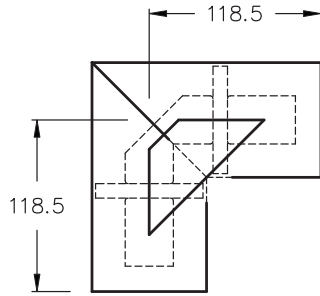

Miter elbow 90°-unflanged, long legs, reinforced outside, copper construction. Includes only one supported inner conductor.

RL 318.25

Line size 3 1/8"

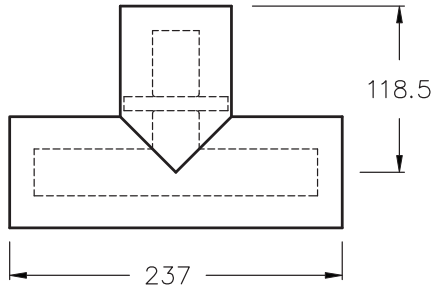

Tee assembly, unflanged, copper construction. Includes only supported inner conductor.

RL 318.28

Line size 3 1/8"

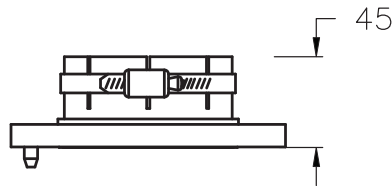

Unpressurized EIA field flange for indoor use. Includes one stainless steel hose clamp and hardware set.

RL 318.30

Line size 3 1/8"

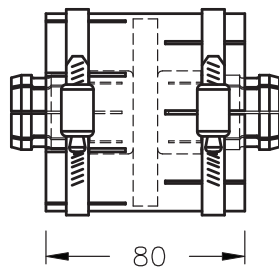

Line coupling for connection of unflanged lines. Includes supported inner conductor connector and two stainless steel hose clamps.

RL 318.32

Line size 3 1/8"

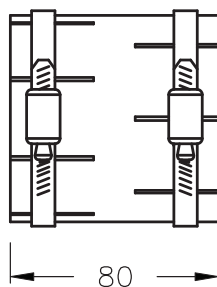

Line coupling for connection of unflanged lines. No inner conductor connector. Includes two stainless steel hose clamps (does not increase outer conductor length).

RL 318.33



* All dimensions shown are in millimeters.
* Drawings not to scale.



Line size 3 1/8"

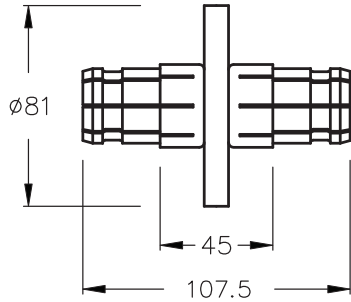

Anchor insulator conductor connector, for EIA flange connection, silver plated. **Standard length.**

RL 318.35

Line size 3 1/8"

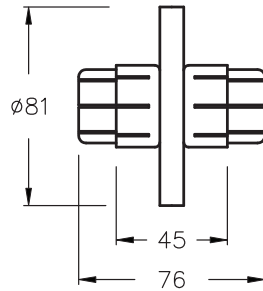

Anchor insulator conductor connector, for EIA flange connection, silver plated. **Short version.**

RL 318.36

Line size 3 1/8"

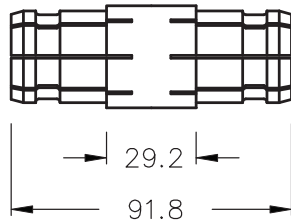

Unsupported inner conductor connector.

RL 318.40

Line size 3 1/8"

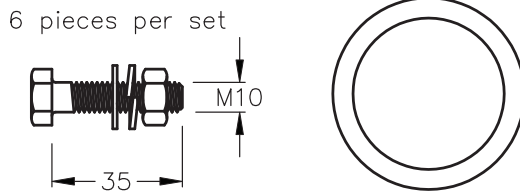

Stainless steel hardware set with silicone rubber O-ring.

RL 318.45

Line size 3 1/8"

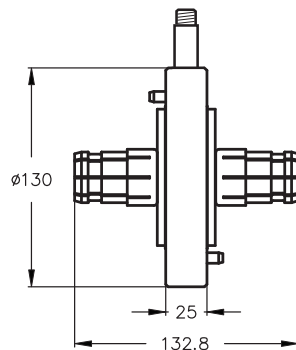

Gas barrier with silicone O-ring and stainless steel hardware set.

RL 318.50



* All dimensions shown are in millimeters.
* Drawings not to scale.

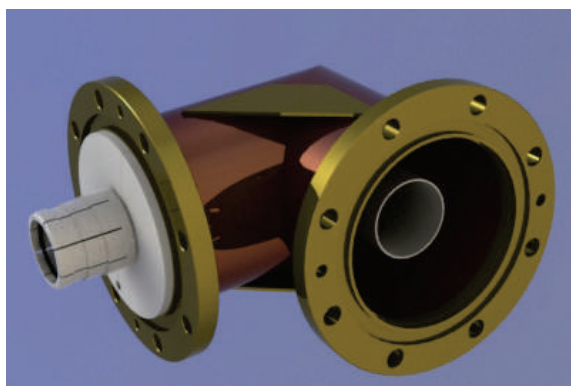
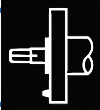

RL 412.11

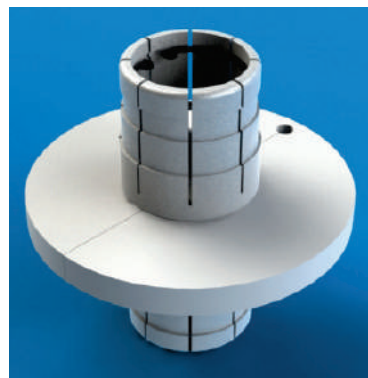

RL 412.35

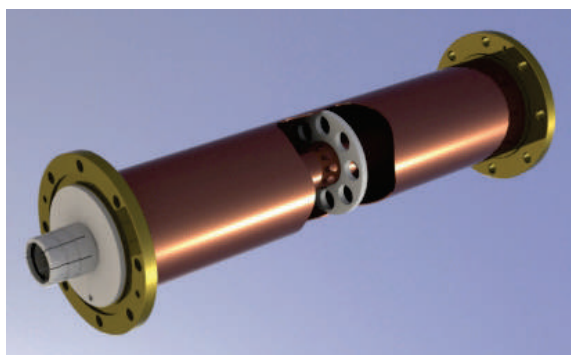

RL 412.01

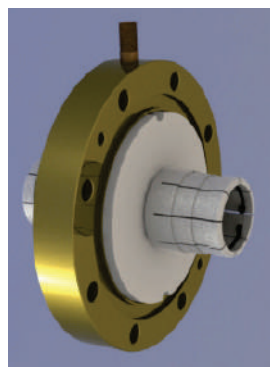

RL 412.50

- Outer Conductor: high conductivity hard drawn copper tubing
($\varnothing 106 \text{ mm.} \times \varnothing 103 \text{ mm.}$)
- Inner Conductor: high conductivity hard drawn copper tubing
($\varnothing 44.7 \text{ mm.} \times \varnothing 42.8 \text{ mm.}$)
- Insulation Material: virgin PTFE

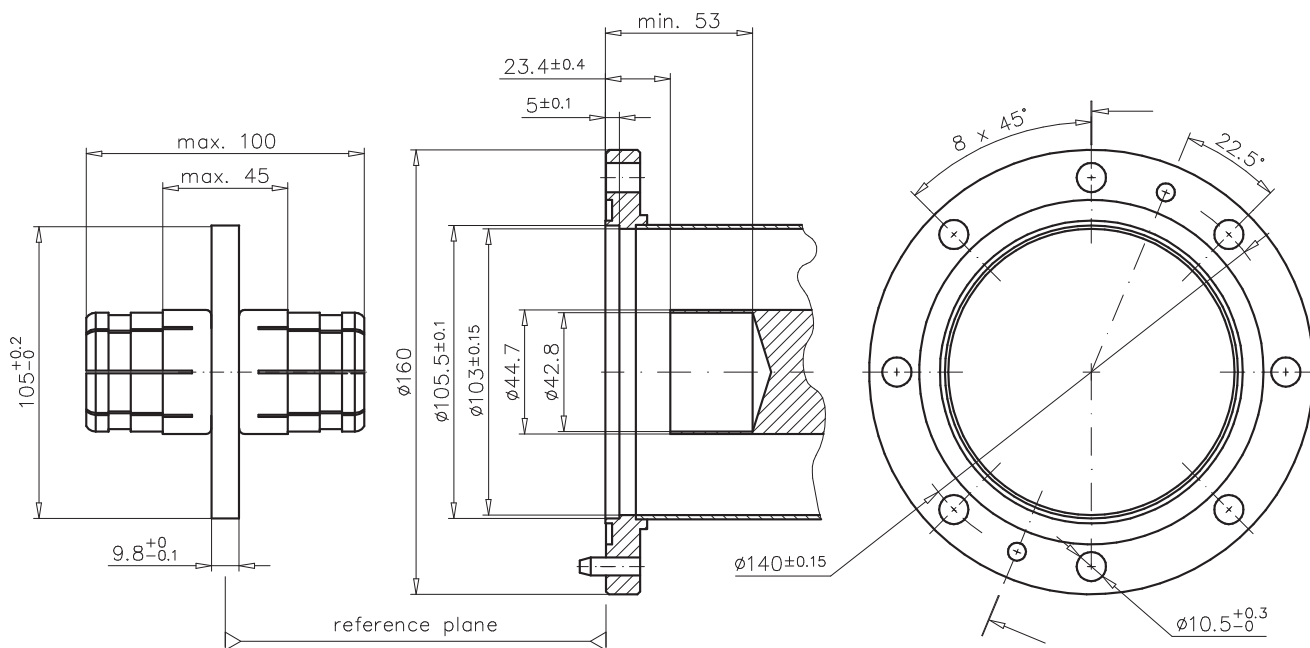

* All dimensions shown are in millimeters.
* Drawings not to scale.

Mating Face Dimension - 4 1/2"



Line size 4 1/2"

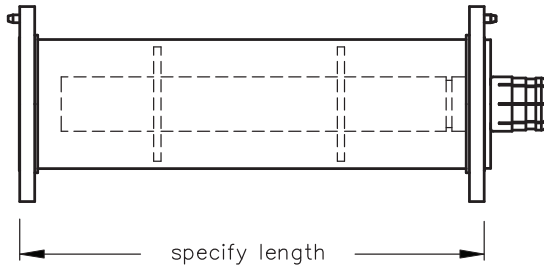

Line assembly, flanged with fixed and swivel flange. Brass and copper construction. Includes one anchor insulator conductor connector, silicone O-ring and stainless steel hardware set.

RL 412.01

Line size 4 1/2"

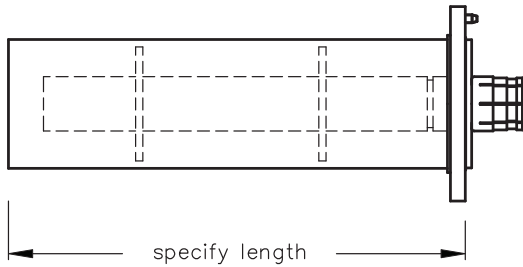

Line assembly, one end fixed flanged. Includes one anchor insulator conductor connector, silicone O-ring and stainless steel hardware set.

RL 412.02

Line size 4 1/2"

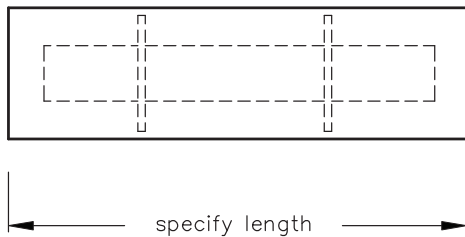

Line assembly, unflanged, no insulator conductor connector or hardware.

RL 412.04

Line size 4 1/2"

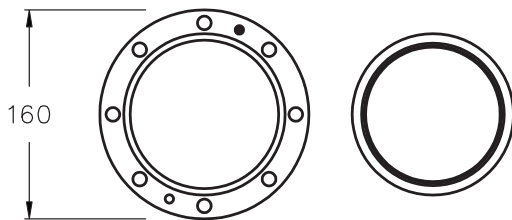

Swivel EIA flange, brass. Includes only sliding and fixed ring prepared for silver brazing to outer conducting tubing.

RL 412.06

Line size 4 1/2"

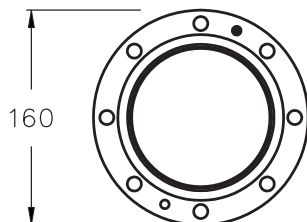

Fixed EIA flange with silver solder ring insert for silver brazing to outer conducting tubing.

RL 412.08



* All dimensions shown are in millimeters.
* Drawings not to scale.



Line size 4 1/2 "

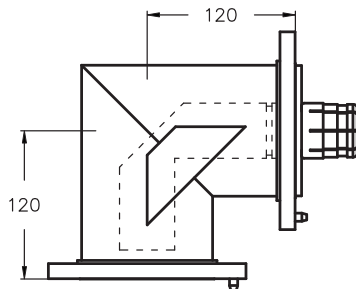

Miter elbow 90°, swivel EIA flanges on both ends, reinforced outside, brass and copper construction. Includes unsupported inner conductor, one anchor insulator conductor connector, silicone O-ring and stainless steel hardware set.

RL 412.11

Line size 4 1/2 "

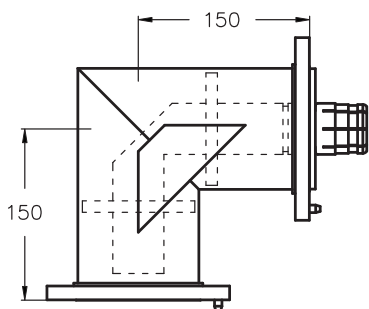

Miter elbow 90°, swivel EIA flanges on both ends, reinforced outside, brass and copper construction. Includes supported inner conductor, anchor insulator conductor connector, silicone O-ring and stainless steel hardware set.

RL 412.14

Line size 4 1/2 "

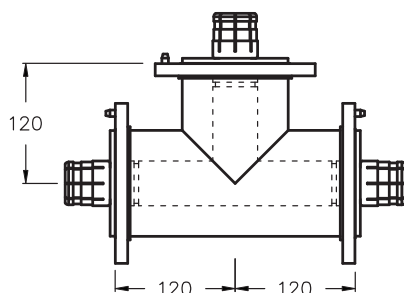

Tee assembly, swivel EIA flanges. Includes three anchor insulator connectors, O-rings and hardware sets.

RL 412.19

Line size 4 1/2 "

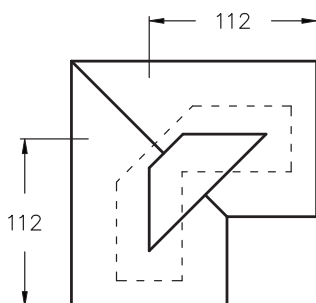

Miter elbow 90°-unflanged, reinforced outside, copper construction. Includes only one unsupported inner conductor.

RL 412.22

Line size 4 1/2 "

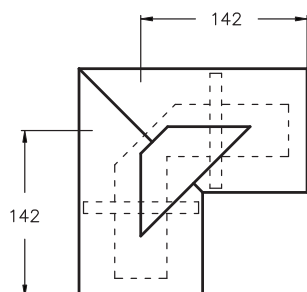

Miter elbow 90°-unflanged, long legs, reinforced outside, copper construction. Includes only one supported inner conductor.

RL 412.25



* All dimensions shown are in millimeters.

* Drawings not to scale.



Line size 4 1/2"

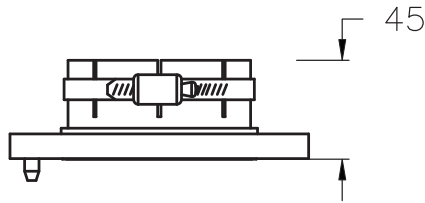

Unpressurized EIA field flange for indoor use. Includes one stainless steel hose clamp and hardware set.

RL 412.30

Line size 4 1/2"

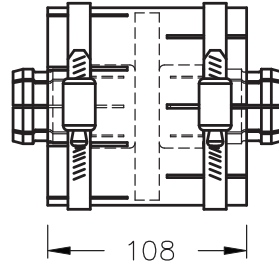

Line coupling for connection of unflanged lines. Includes supported inner conductor connector and two stainless steel hose clamps.

RL 412.32

Line size 4 1/2"

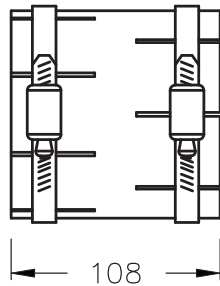

Line coupling for connection of unflanged lines. No inner conductor connector. Includes two stainless steel hose clamps (does not increase outer conductor length).

RL 412.33

Line size 4 1/2"

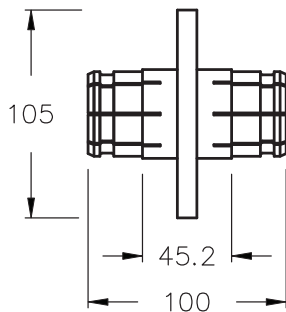

Anchor insulator conductor connector, for EIA flange connection, silver plated. **Standard length.**

RL 412.35

Line size 4 1/2"

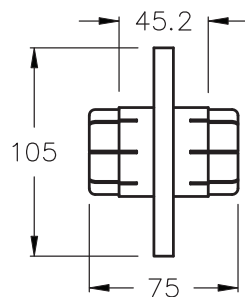

Anchor insulator conductor connector, for EIA flange connection, silver plated. **Short version.**

RL 412.36



* All dimensions shown are in millimeters.
* Drawings not to scale.



Line size 4 1/2 "

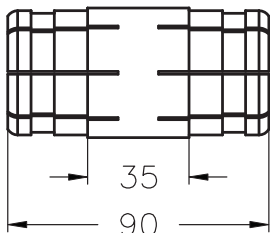

Unsupported inner conductor connector.

RL 412.40

Line size 4 1/2 "

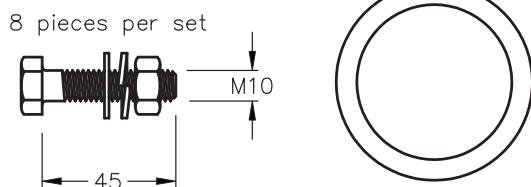

Stainless steel hardware set with silicone rubber O-ring.

RL 412.45

Line size 4 1/2 "

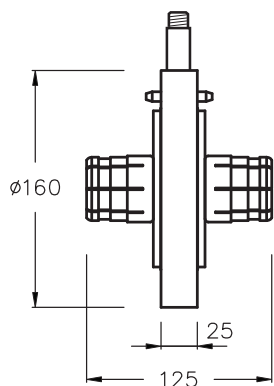

Gas barrier with silicone O-ring and stainless steel hardware set.

RL 412.50



* All dimensions shown are in millimeters.
* Drawings not to scale.

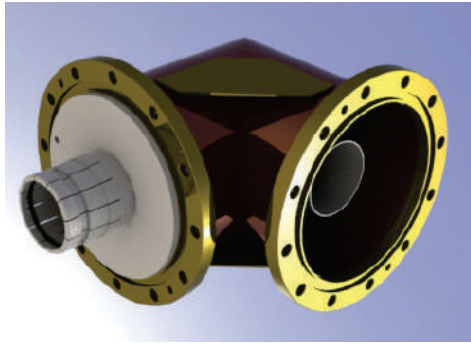
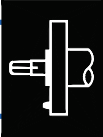

RL 618.11

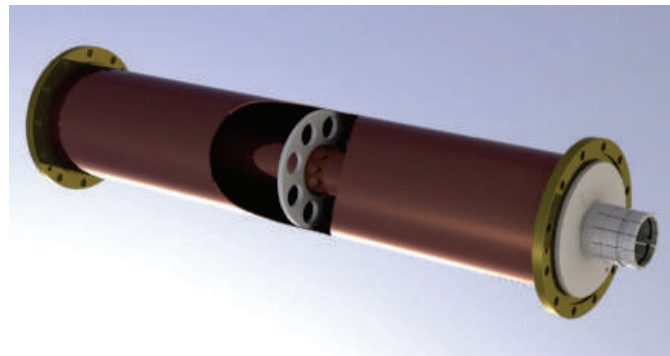

RL 618.01



RL 618.35

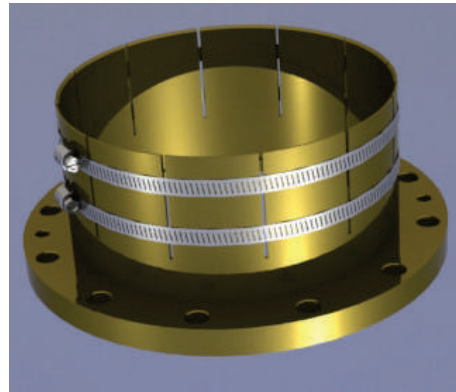

RL 618.50

- Outer Conductor: high conductivity hard drawn copper tubing ($\varnothing 155,6 \text{ mm.}$ x $\varnothing 151,9 \text{ mm.}$)
- Inner Conductor: high conductivity hard drawn copper tubing ($\varnothing 66 \text{ mm.}$ x $\varnothing 64 \text{ mm.}$)
- Insulation Material: virgin PTFE

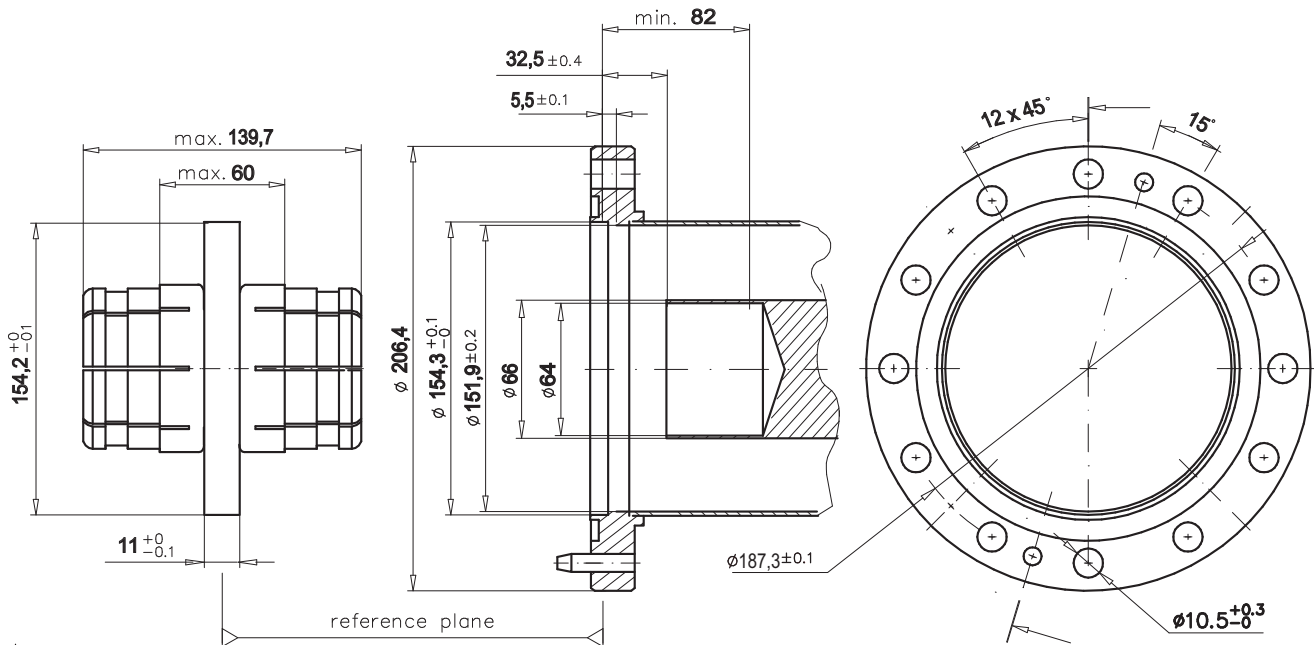

Mating Face Dimension - 6 1/8"



* All dimensions shown are in millimeters.
 * Drawings not to scale.



Line size 6 1/8"

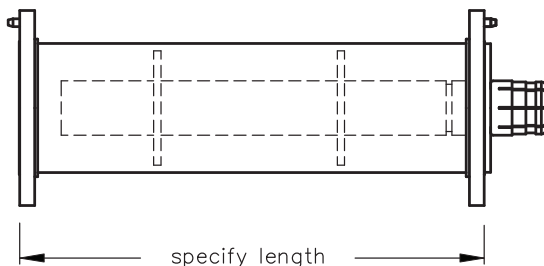

Line assembly, flanged with fixed and swivel flange. Brass and copper construction. Includes one anchor insulator conductor connector, silicone O-ring and stainless steel hardware set.

RL 618.01

Line size 6 1/8"

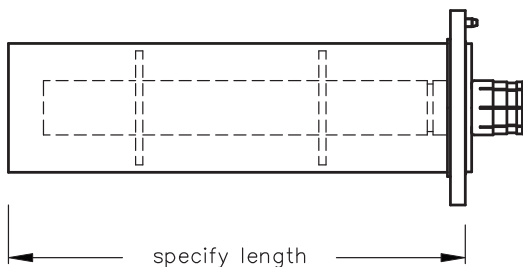

Line assembly, one end fixed flanged. Includes one anchor insulator conductor connector, silicone O-ring and stainless steel hardware set.

RL 618.02

Line size 6 1/8"

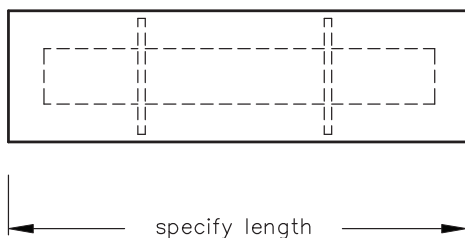

Line assembly, unflanged, no insulator conductor connector or hardware.

RL 618.04

Line size 6 1/8"

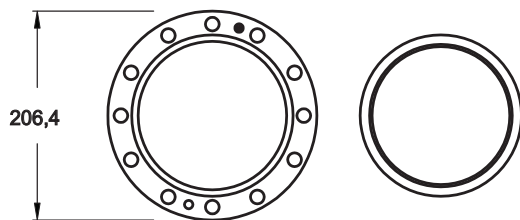

Swivel EIA flange, brass. Includes only sliding and fixed ring prepared for silver brazing to outer conducting tubing.

RL 618.06

Line size 6 1/8"

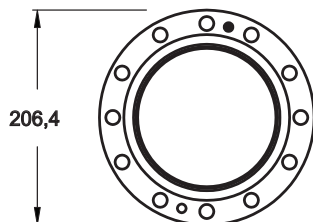

Fixed EIA flange with silver solder ring insert for silver brazing to outer conducting tubing.

RL 618.08



* All dimensions shown are in millimeters.
* Drawings not to scale.



Line size 6 1/8"

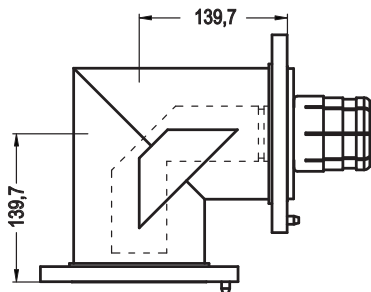

Miter elbow 90°, swivel EIA flanges on both ends, reinforced outside, brass and copper construction. Includes unsupported inner conductor, one anchor insulator conductor connector, silicone O-ring and stainless steel hardware set.

RL 618.11

Line size 6 1/8"

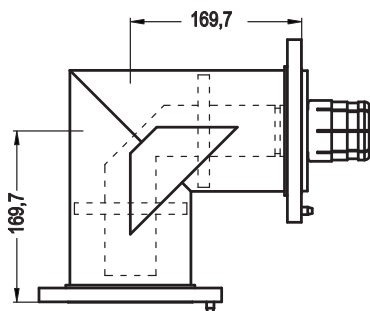

Miter elbow 90°, swivel EIA flanges on both ends, reinforced outside, brass and copper construction. Includes supported inner conductor, anchor insulator conductor connector, silicone O-ring and stainless steel hardware set.

RL 618.14

Line size 6 1/8"

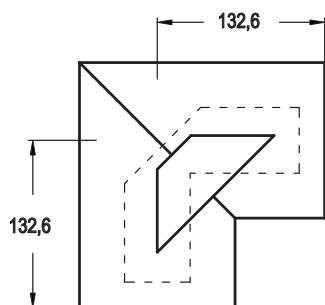

Miter elbow 90°-unflanged, reinforced outside, copper construction. Includes only one unsupported inner conductor.

RL 618.22

Line size 6 1/8"

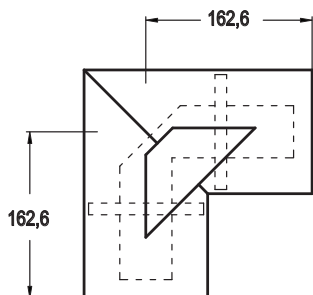

Miter elbow 90°-unflanged, long legs, reinforced outside, copper construction. Includes only one supported inner conductor.

RL 618.25

Line size 6 1/8"

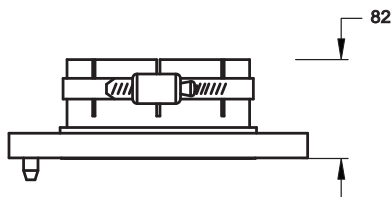

Unpressurized EIA field flange for indoor use. Includes one stainless steel hose clamp and hardware set.

RL 618.30



* All dimensions shown are in millimeters.
* Drawings not to scale.



Line size 6 1/8"

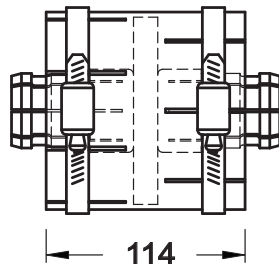

Line coupling for connection of unflanged lines. Includes supported inner conductor connector and two stainless steel hose clamps.

RL 618.32

Line size 6 1/8"

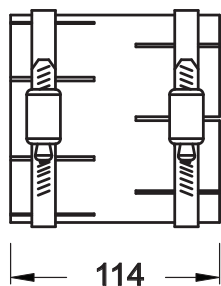

Line coupling for connection of unflanged lines. No inner conductor connector. Includes two stainless steel hose clamps (does not increase outer conductor length).

RL 618.33

Line size 6 1/8"

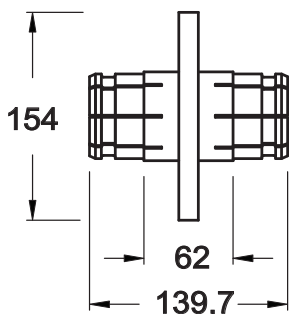

Anchor insulator conductor connector, for EIA flange connection, silver plated. **Standard length.**

RL 618.35

Line size 6 1/8"

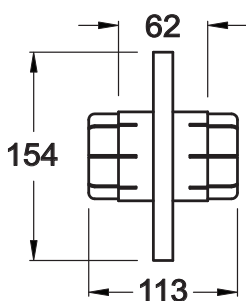

Anchor insulator conductor connector, for EIA flange connection, silver plated. **Short version.**

RL 618.36

Line size 6 1/8"

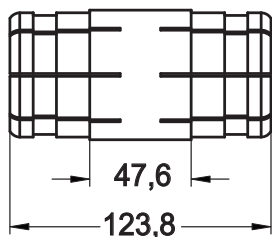

Unsupported inner conductor connector.

RL 618.40



* All dimensions shown are in millimeters.

* Drawings not to scale.



Line size 6 1/8"

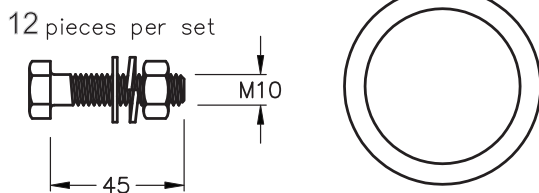

Stainless steel hardware set with silicone rubber O-ring.

RL 618.45

Line size 6 1/8"

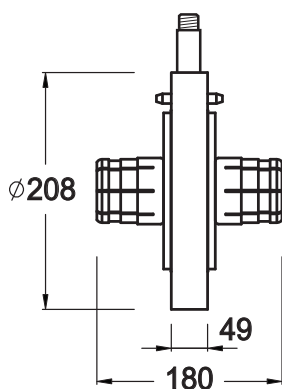

Gas barrier with silicone O-ring and stainless steel hardware set.

RL 618.50



* All dimensions shown are in millimeters.
* Drawings not to scale.